

The Steadman AS6 Fibre Cement Sheeting is recognised as a superior alternative to Asbestos Cement. The AS6 sheet is non-toxic and does not represent a health hazard. All Steadman AS6 sheets are reinforced to meet the HSE Regulations and CDM Drop Tests. (As with all fibre-based products the wearing of breathing masks and goggles when cutting is advised. Please see Steadmans guide to Storage and Handling).

**ENVIRONMENTAL
ASBESTOS-FREE**

AS6 FIBRE CEMENT SHEET

Nominal width	1086mm
Net cover	1016mm
End lap	(min)150mm
Side lap	70mm
Purlins Centres	(max)1375mm
Clear Span	(max)1300mm
Rail Centres	(max)1825mm
Span between rails	(max)1750mm
Unsupported overhang	(max)400mm

TOLERANCES

Length	+5 -10mm
Cover width	+8 -2mm
Overall width	+10 -5mm
Thickness	+free -0

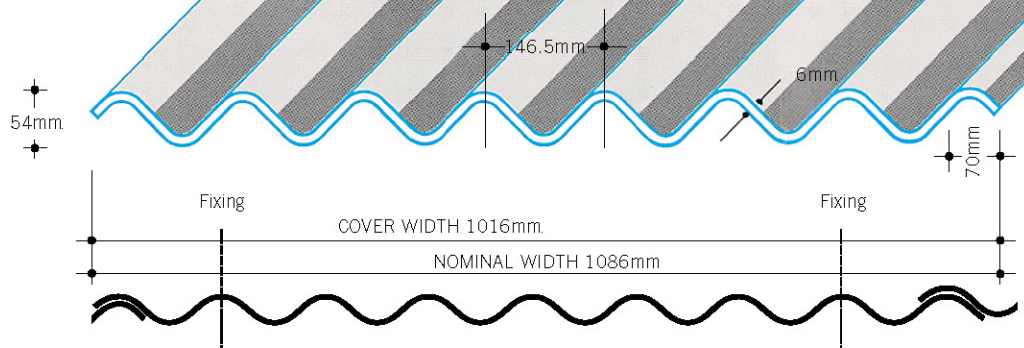

LENGTHS AVAILABLE FROM STOCK

	1525	1675	1825	1980	2130	2280	2440	2600	2750	2900	3050
Length of sheet in mm	1525	1675	1825	1980	2130	2280	2440	2600	2750	2900	3050
Length of sheet in feet	5'0"	5'6"	6'0"	6'6"	7'0"	7'6"	8'0"	8'6"	9'0"	9'6"	10'0"
Number of sheets per tonne	46	43	39	36	33	31	29	28	26	25	23
Area of sheet in sq.metres	1.66	1.82	1.99	2.15	2.31	2.48	2.65	2.82	2.98	3.15	3.31

LAP CONDITIONS

NORMAL SITE			
MIN. SHEET PITCH	END LAP	END LAP SEALED	SIDE LAP SEALED
22.5°	150	–	–
15°	150	–	–
10°	150	YES	–
5°	150	DOUBLE	YES

EXPOSED SITE			
MIN. SHEET PITCH	END LAP	END LAP SEALED	SIDE LAP SEALED
25°	150	–	–
15°	150	YES	–
10°	150	YES	YES
5°	300	DOUBLE	YES

ENVIRONMENTAL • ASBESTOS • FREE FITTINGS & ACCESSORIES

A full range of fixings available.

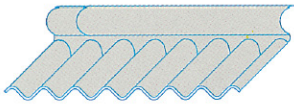

CLOSE FITTING RIDGE

2 piece adjustable inner and outer Length: 1086mm



UNDER GLAZING FLASHING PIECE

Length: 1086mm

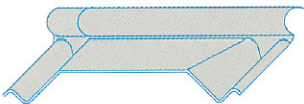

VENTILATING RIDGE

2 piece adjustable inner and outer length: 1086mm

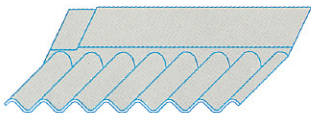

APRON FLASHING PIECE

Length: 1086mm

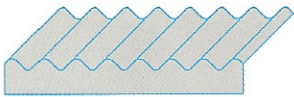

EAVES FILLER

50mm nib

Length: 1086mm



Juniper Green 12B29*
Merlin Grey 18B25*
Slate Blue 18B29*
Van Dyke Brown 08B29*

*Nearest British Standard Colour

See Steadman's colour guide chart for available colours.

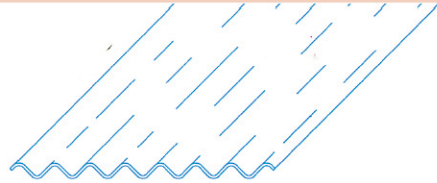

ROOF LIGHT SHEET

Available in GRP 8oz 1.44 Kg/m² or PVC.

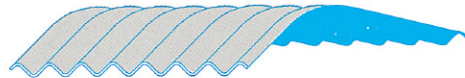

CROWN CRANKED CLOSE FITTING RIDGE SHEET

Width: 1086mm

Girth: 750mm or 900mm

Radius: 300mm

Pitch: 10°, 12.5°, 15°, 17.5°, 20° or 22.5°

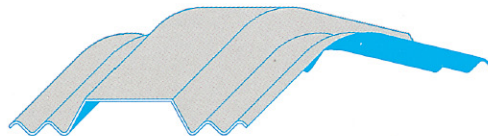

CROWN CRANKED VENTILATED RIDGE SHEET

Width: 1086mm

Girth: 750mm or 900mm

Radius: 300mm

Pitch: 10°, 12.5°, 15°, 17.5°, 20° or 22.5°



PROTECTED OPEN RIDGE

Length: 1600mm

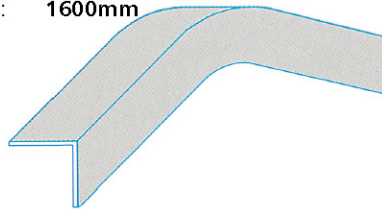

CRANKED CROWN BARGE BOARD

200 x 200mm or 300 x 300mm

Girth: 1300mm

Pitch: 10°, 12.5°, 15°, 17.5°, 20° or 22.5°

STANDARD PLAIN ANGLE BARGE BOARD

200 x 200mm or 300 x 300mm

Lengths: 1800mm,

2440mm,

3050mm

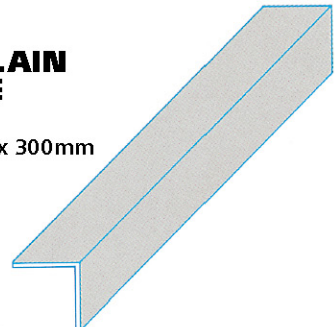

- Advice on correct storage procedures.
- Information on safe and efficient handling.
- Recommended fixings and methods.
- Correct laying procedures.

ESSENTIAL PROCEDURES

Steadmans' Fibre Cement Cladding Products are manufactured to a high quality and to comply with British and European standards. It is essential that the products are stored, handled and fixed correctly. It is recommended that roofing, wall sheets and

accessories are fitted by experienced contractors. Once the products have been collected or delivered to site, it is the responsibility of the customer, or his agent, to store, handle and protect them.

HANDLING

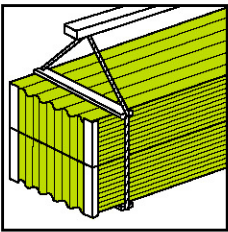

The majority of deliveries, via Steadmans, are off-loaded by piggy-back fork-lift. However, subsequent crane handling should be careful to avoid damage to the edges of the sheets. Use rope slings (not chains) and over-width spreaders to eliminate the possibility of damaging the edges of the sheets. The corners of the sheets are particularly vulnerable during any transportation period.

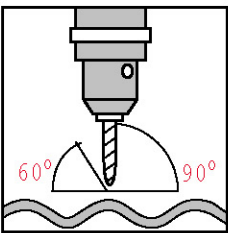

Using a tungsten carbide tipped drill at 90° angle to the sheet, drill a hole 4mm larger than the selected fixing. The drill point should be no less than 60° to the sheet. Always drill at the 'apex' of the rise of the profile. Do not fix a sheet in the 'valley' or on a 'slope' of the profile.

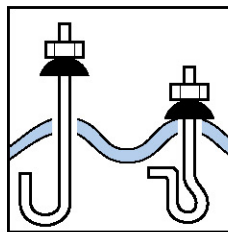

Steadmans stock a range of fixings for their fibre cement products. Hook and crook bolts are commonly used to secure the sheets. Clearance holes 4mm larger than the fixing should be pre-drilled to accept the fixing. The appropriate washer must be used to seal the operation.

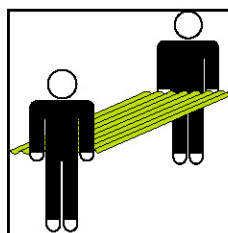

If an on-site lift facility is unavailable, each sheet should be carefully removed by hand as described above. Once removed, they should be manoeuvred into position by two men, one at each end. Particular care should be taken in windy conditions.

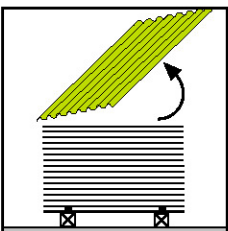

Never push, drag or slide a sheet from a stack. Always consciously remove the sheet by lifting from the stack. Similarly, lift the sheet into position on a roof; do not push or drag over the purlins or other roof sheets.

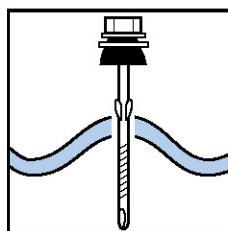

It is particularly recommended that a self drilling Top-Fix screw is adopted. This simple operation offers a fast, low cost fixing solution. Using a high speed screw gun, drive in the fixing. The fixing system is in accordance with BS8219:2001. This type of fixing is only suitable for roofs up to and including 15° pitch.

Handling & Storage

Fibre Cement Cladding & Roofing Products

STORAGE



Coloured sheets and accessories should ideally be stored inside a building. Until the sheets are in position on the building they could be subject to damage from site debris, and accidental collision. Rainwater, condensation and extreme weather conditions can also adversely affect the sheets (particularly colour sheets) during this storage period.

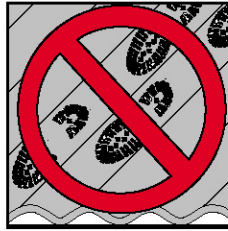

NEVER walk on the sheets, whether on the ground, on the stack or fixed on the roof.

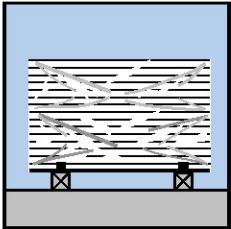

The sheets are supplied covered in shrink-wrapping. It is strongly recommended that the wrapping is **NOT** removed until the sheets are required for fixing. Should any sheets remain unused at the end of the working period, the edges of all the sheets **MUST BE RE-COVERED**.

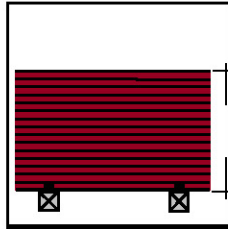

Stacks without additional timber cross bearers should not exceed 1200mm. Cross bearers should be no more than 1 metre apart. Different length sheets should ideally be stacked separately, but if stacked with longer sheets they must be laid on the top and their cross bearers must line up vertically.

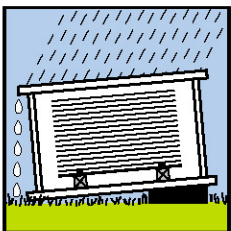

If it is not possible to store the product inside a building, a suitable site should be selected. The ground should be firm and level and as close to the construction work as possible. The sheets must be stacked on cross bearers, thus raising them off the ground. A simple protective frame should be constructed and covered with a waterproof material. Air must be allowed to circulate all round the stack. The whole frame and stack should be tilted to encourage rainwater to drain freely.

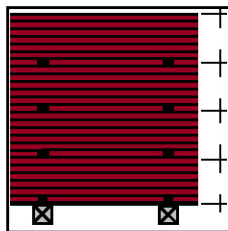

If several stacks are to be laid, one on top of the other, timber cross bearers should be placed at 500mm intervals up to a maximum height of 3000mm. It is important that the ground is level and firm.

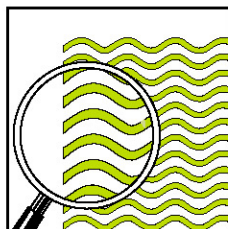

Whether the product is stored inside or outside, the stacks should be regularly inspected to ensure that moisture has not penetrated the coverings. Coloured sheets are particularly vulnerable at this stage.

FIXING

PRECAUTIONS AND PROCEDURES

It is extremely important that the correct roof purlin/rail system, type of fixings and washers are selected to eliminate leakage/corrosion and the general deterioration of the construction.

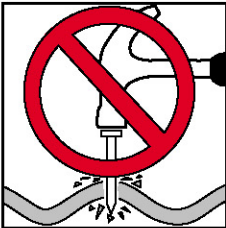

NEVER hammer fixings through the sheet. This will invalidate the guarantee. Fibre cement sheets will shatter under impact and subsequently allow water to penetrate the apparent fixing. **ALWAYS** pre-drill.

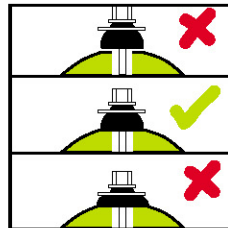

To achieve a watertight and weathertight seal, it is important to confirm that the sealing washer is correctly tightened. Not over tight, not too loose. After a period of time, when the material has settled, the fixings may require re-tightening with hand-tools. be sure to use roof ladders to avoid walking on the roof sheets.

Fixings/General Guidance.

Fibre Cement Sheets should always be fixed with two fasteners per sheet per purlin.

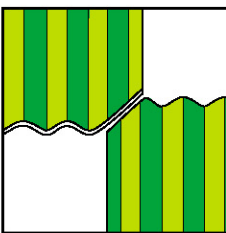
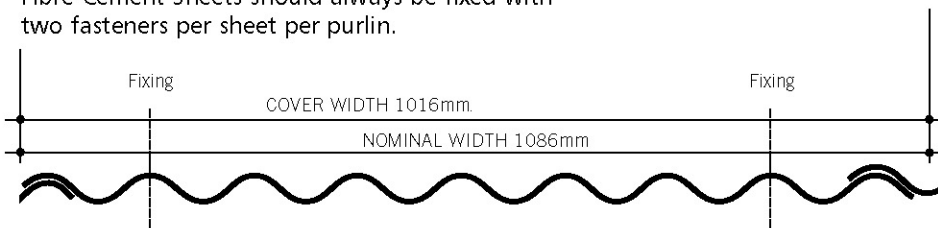

LAYING PROCEDURE

To reduce the overlapping of four roof sheets, the corners of two sheets must be mitred. Each mitre must be cut straight and cleanly either by hand or powersaw. The angle and size of mitre is governed by the profile of the sheet and the end and side lap dimensions. It is recommended that a good quality butyl mastic strip is involved in the joining of the overlapping sheets to provide a weathertight seal.

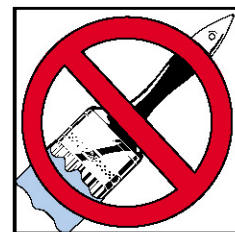
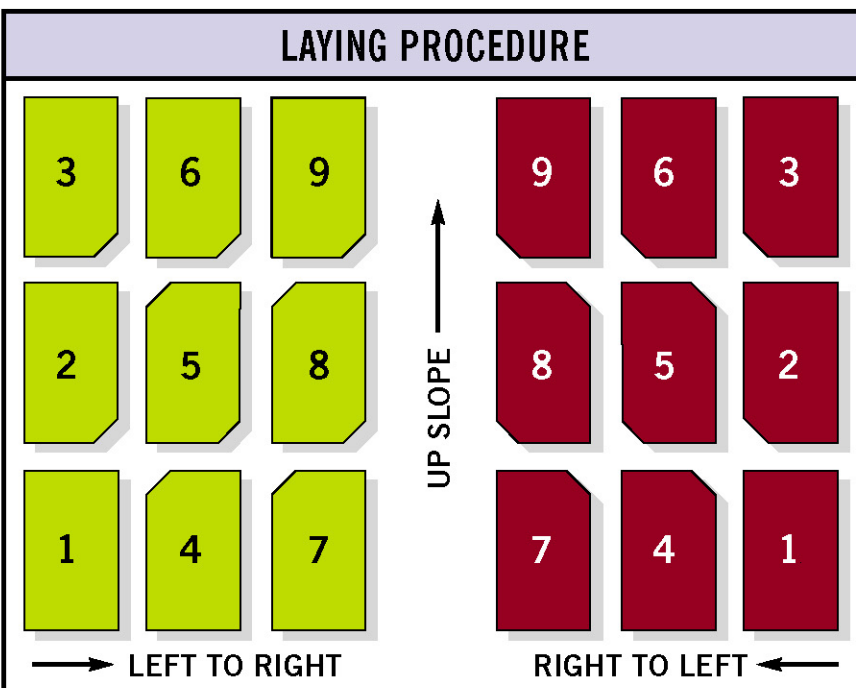

NEVER paint fibre cement products. The guarantee will be invalidated if the product is painted after it has left Steadmans' warehouse.



NEVER walk on the sheets, whether on the ground, on the stack or fixed on the roof.