

Purlin Connections

Side Rail Purlin Connection

Please contact the Sales Office for our complete Purlin guide.

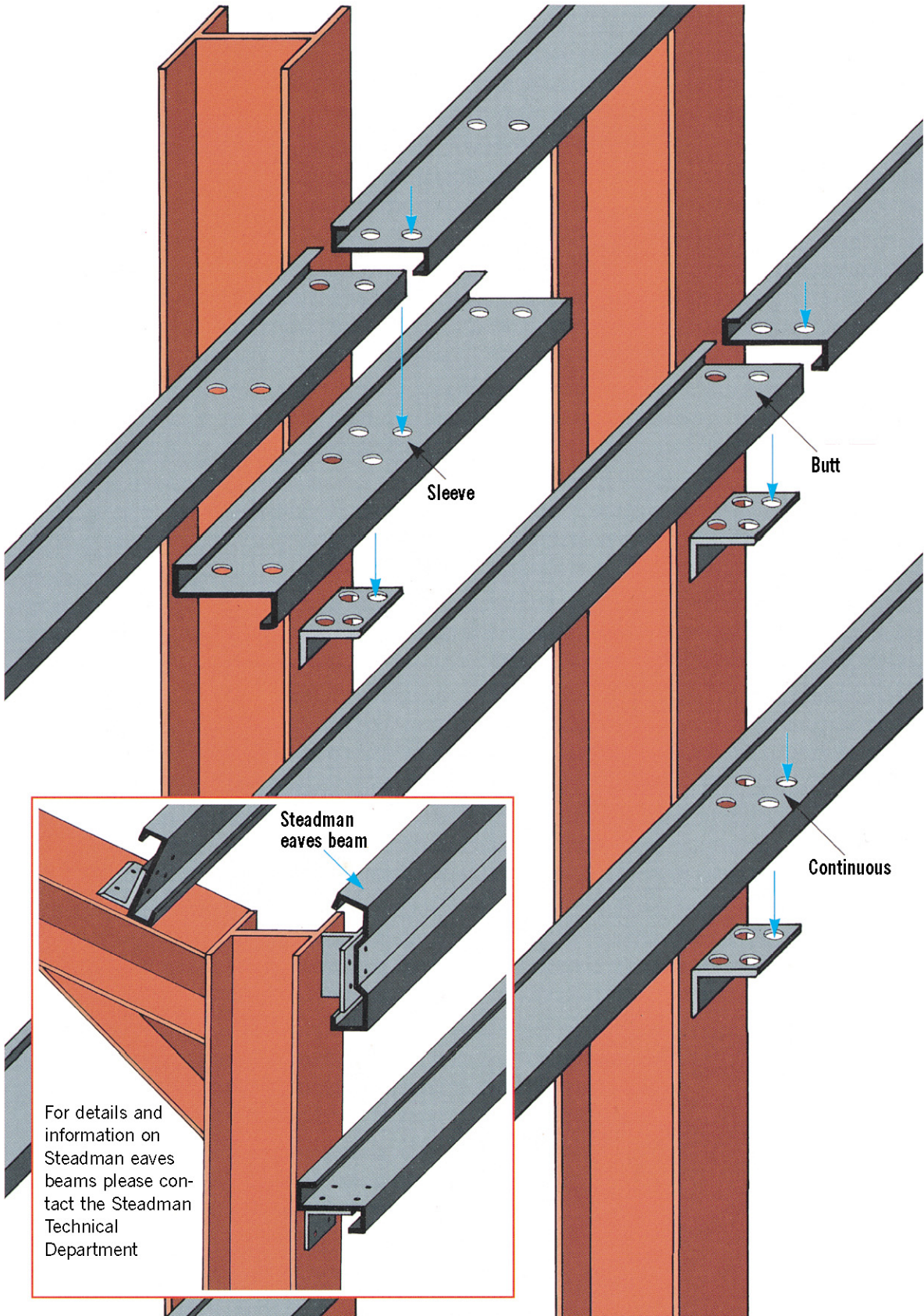

Purlin Connection

Roof Purlin Connections

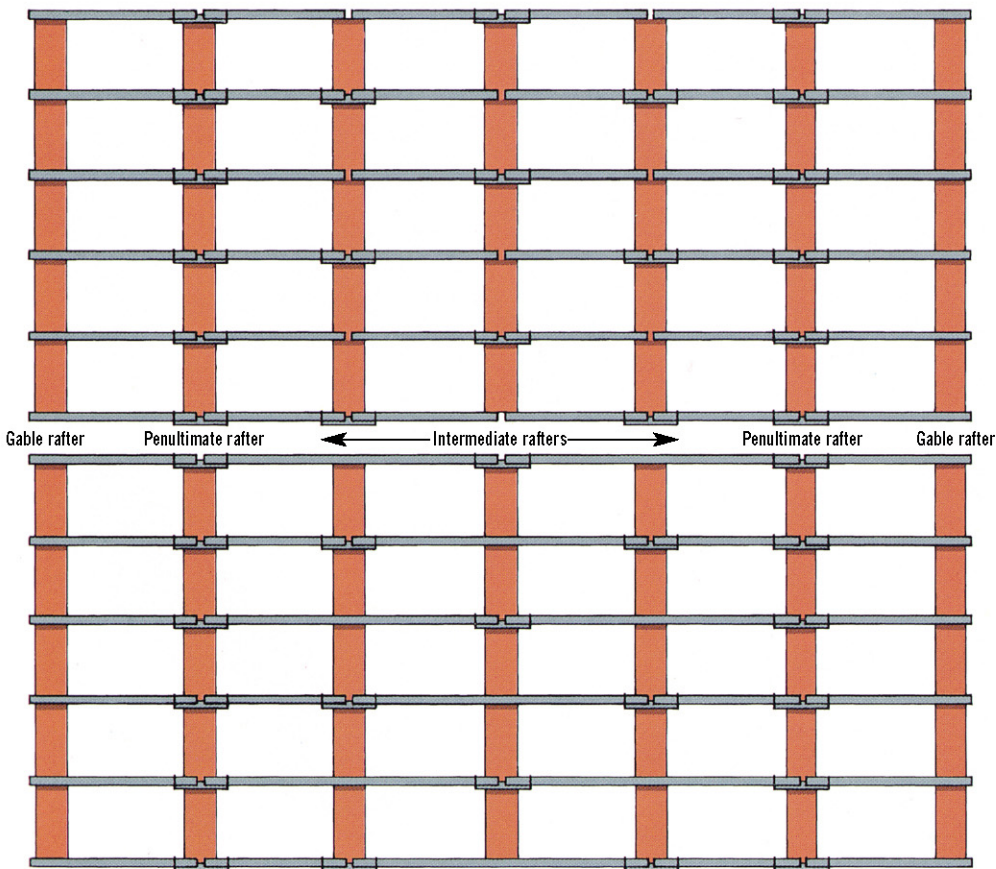
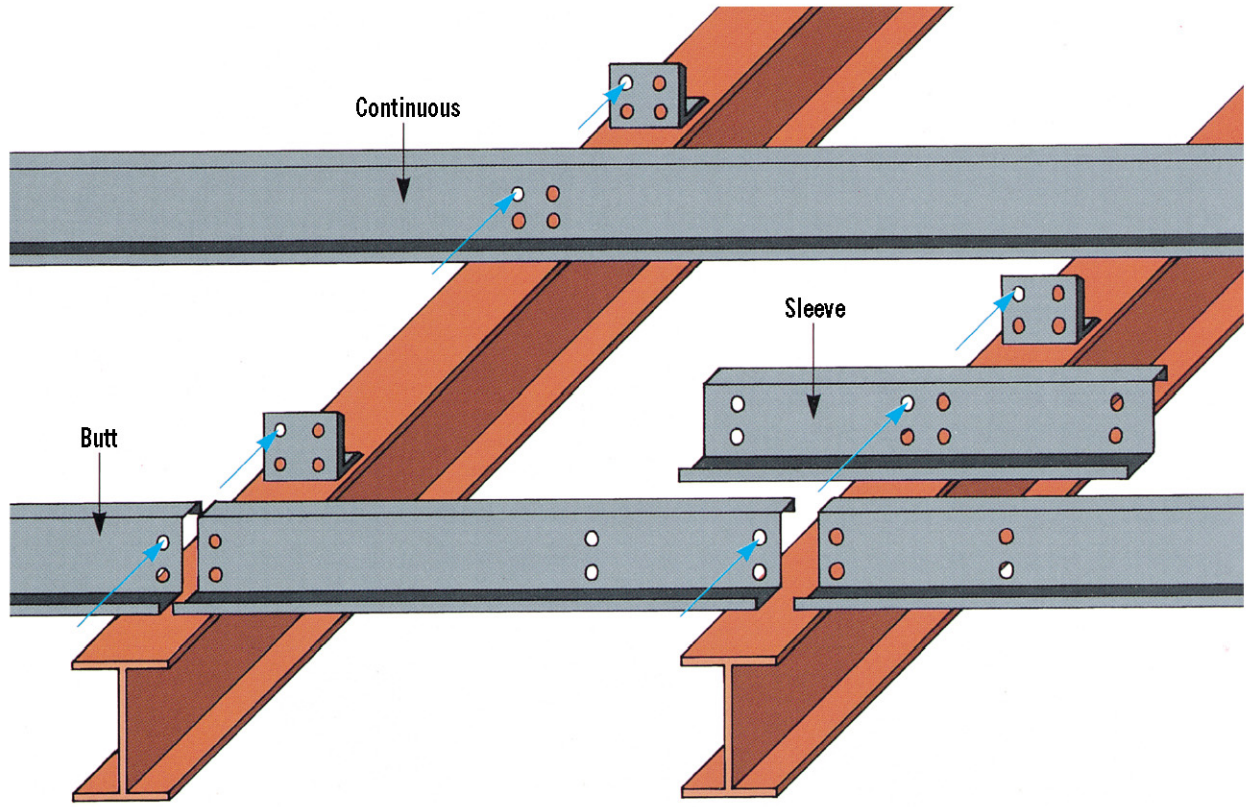

PURLIN OR SIDE RAIL ARRANGEMENT SINGLE SPAN LENGTHS

Sleeves required on all purlins on penultimate rafters and on alternate joints on intermediate rafters.

PURLIN OR SIDE RAIL ARRANGEMENT SINGLE AND DOUBLE SPAN LENGTHS

All butt joints should be connected using a standard cleat details.

Purlin Sections

Standard Hole Punching

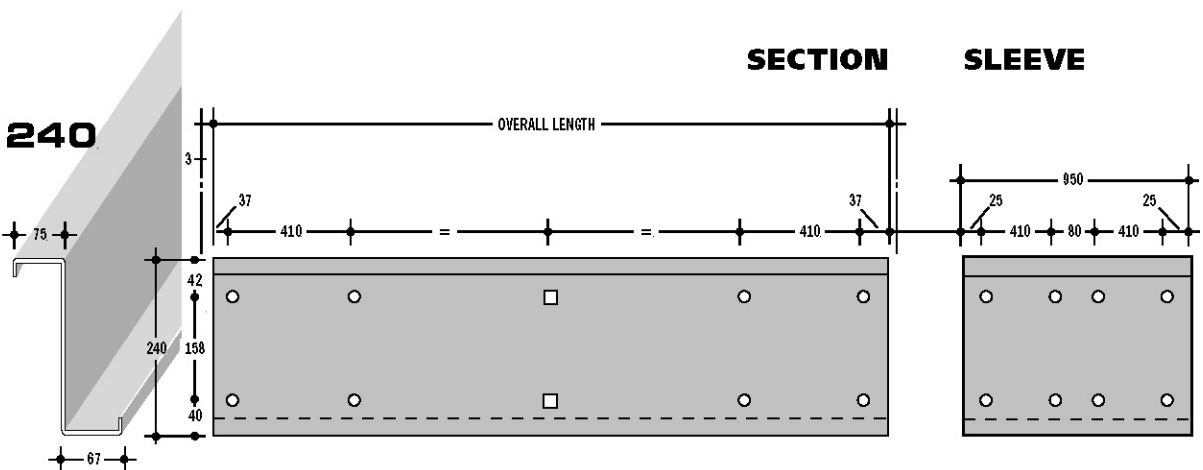
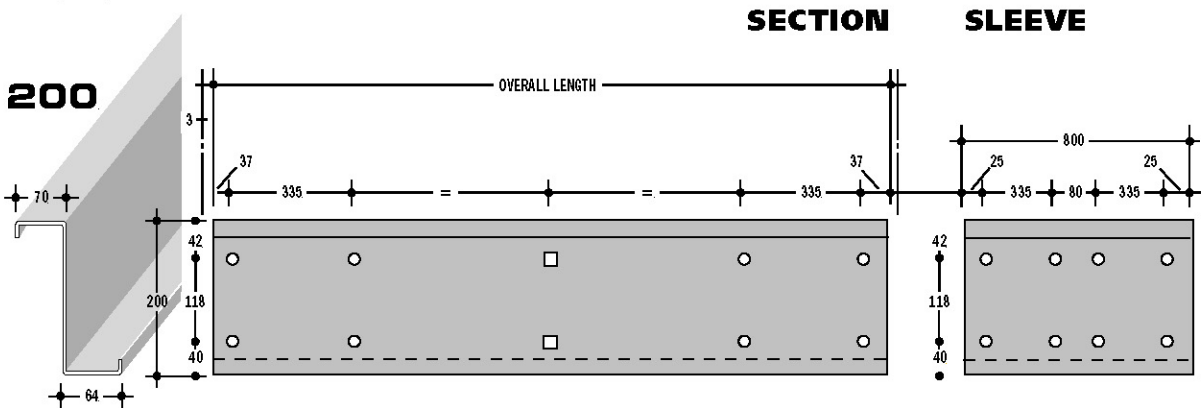
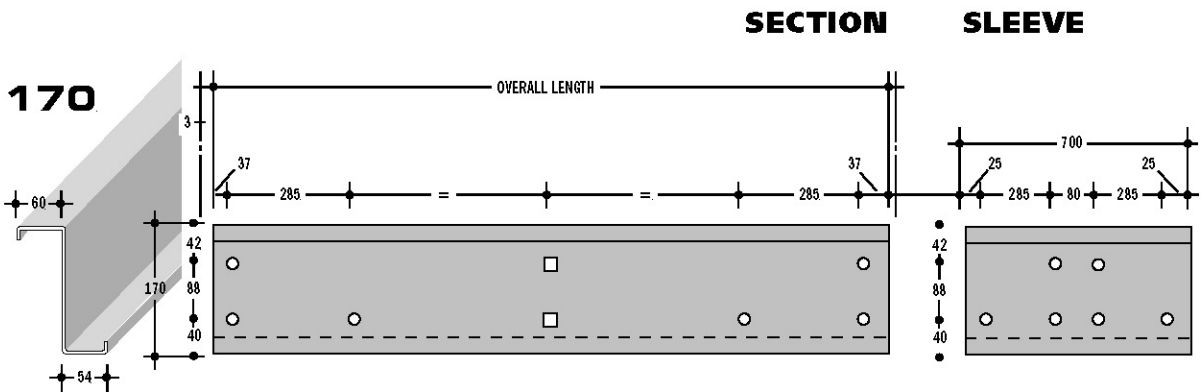
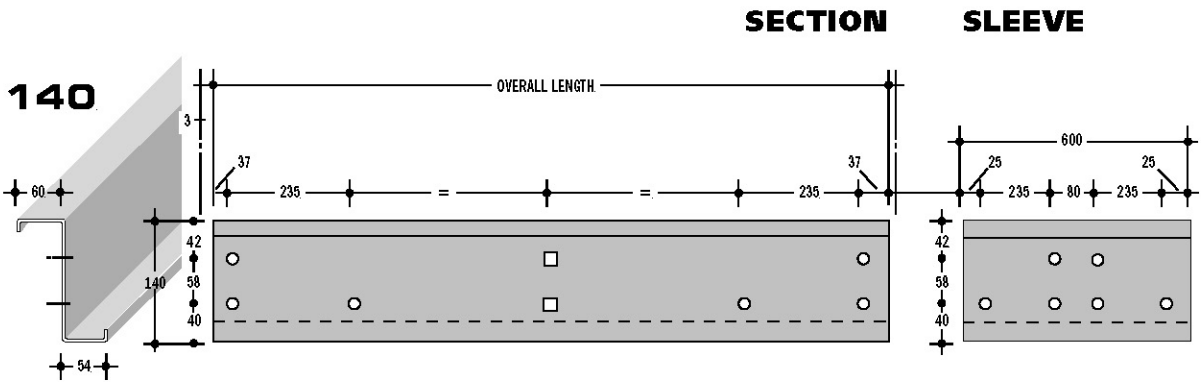

Purlin Sections

Cleat & Sag Bars

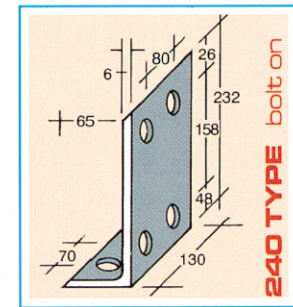
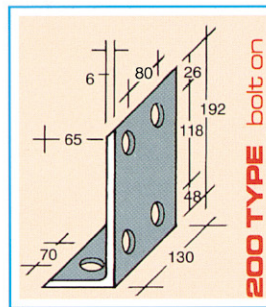
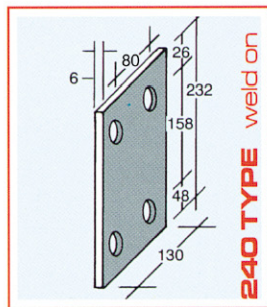
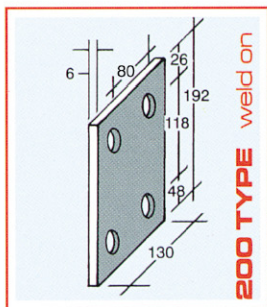
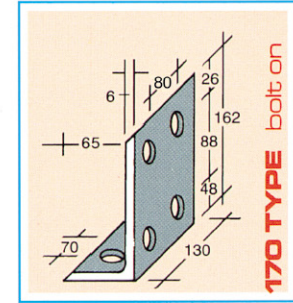
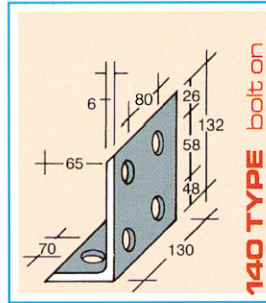
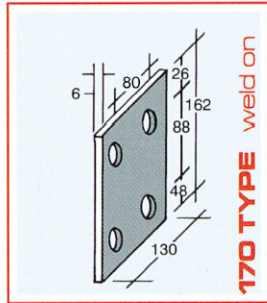
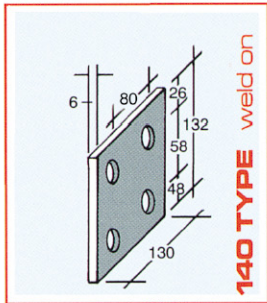

ANTI-SAG BARS

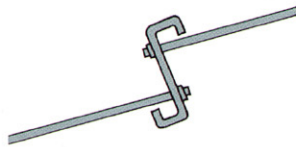
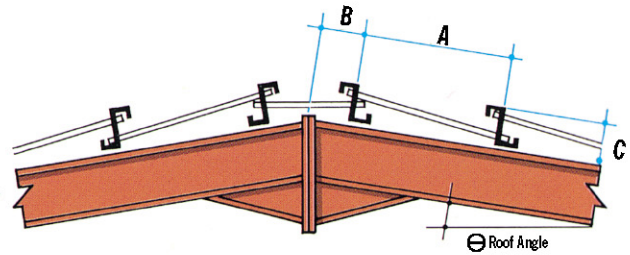
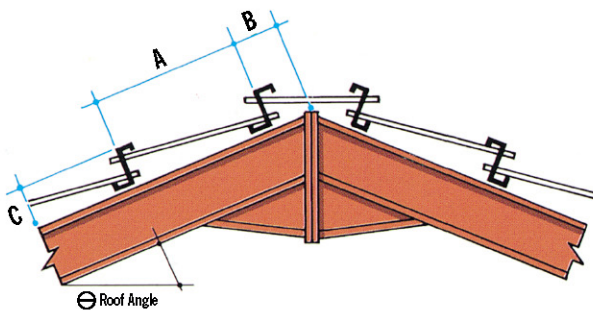

Steadman standard push fit anti-sag bars

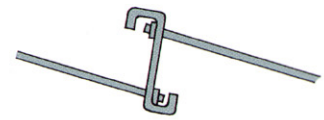

MONO PITCHED ROOF LAYOUT AND ANTI-SAG BAR GUIDE

